

PLAN AVEC DIMENSIONS ET COMPILATION FICHE D/11

INDIQUER LES DIMENSIONS, LE SENS D'OUVERTURE (G. OU DR.) ET LA TYPOLOGIE D'INSTALLATION (EN APPUI OU AU RAS DU SOL)

DISENIA
ARCHITECTURAL SHOWERS

DISENIA S.R.L.
Via A. Carpenè, 21 - 33070 - Maron di Brugnera (PN)
Tel. +39 0434 613643 - Fax + 39 0422 742067
www.disenia.it ideagroup@ideagroup.it export@ideagroup.it

Date Modèle Revendeur
Notes Installateur

**NOUS VOUS SUGGERONS DE JOINDRE
UNE PHOTO DE L'ESPACE DOUCHE**

SENS D'OUVERTURE
GAUCHE

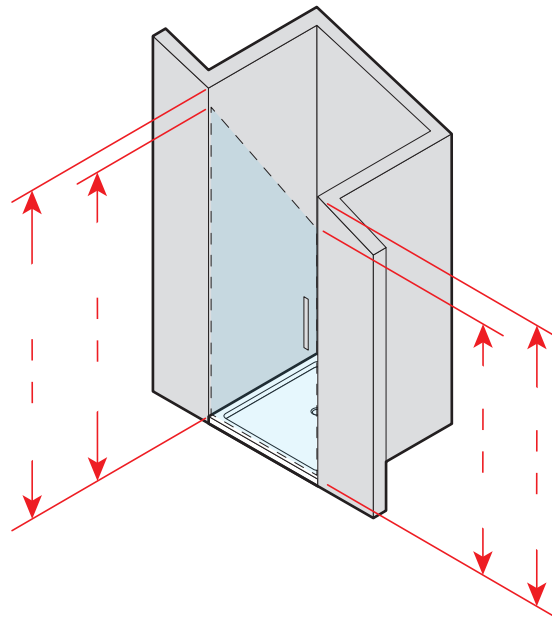
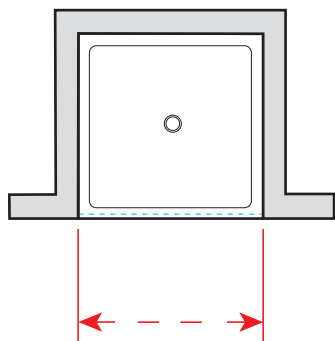

SENS D'OUVERTURE
DROITE

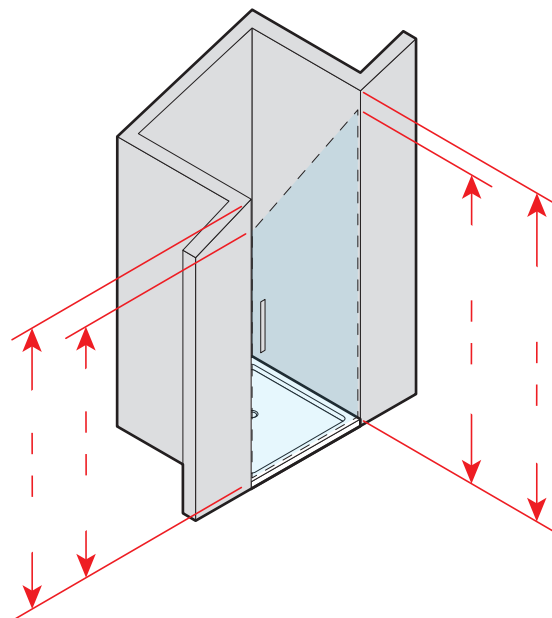
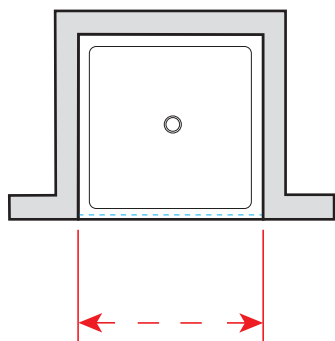

EN APPUI

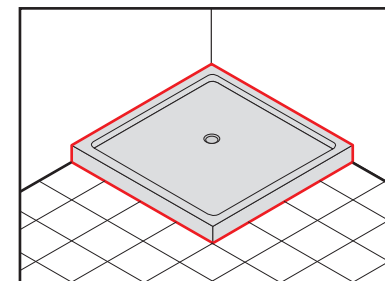

POSE STANDARD

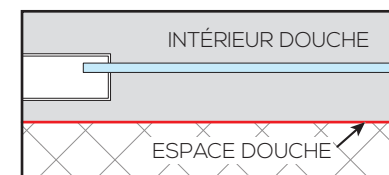

À FLEUR DU SOL

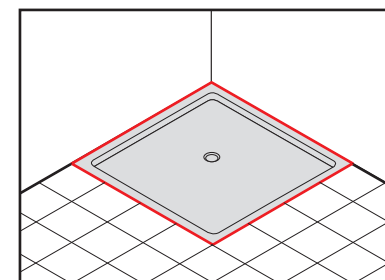

INSTALLATION DU PROFILÉ
À L'INTÉRIEUR

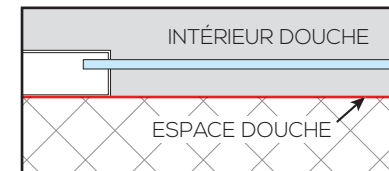

INSTALLATION DU PROFILÉ
À L'EXTÉRIEUR

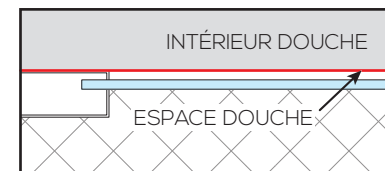

INSTALLATION DU VERRE
À L'INTÉRIEUR

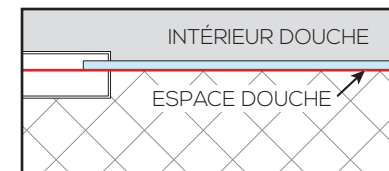

INSTALLATION DU VERRE
À L'EXTÉRIEUR DU JOINT

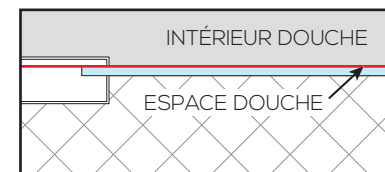

INSTALLATION DU VERRE
AU MILIEU DU JOINT

