

LAB SMALL

MATÉRIAU: CORIAN
BONDE: UP & DOWN - EN TEINTE

POIDS NET: 85 Kg
POIDS BRUT: 115 Kg
DIMENSIONS DE L'EMBALLAGE: VARIABLE
CAPACITÉ: 230 LITRES
RÉGLAGE DES PIEDS: 10 mm
DIAMÈTRE D'ÉCOULEMENT: 4 cm
TOLÉRANCE: ± 5 mm

PRÉVOIR ESPACE NÉCESSAIRE DANS LE SOL
POUR LE LOGEMENT DE LA BONDE ET SIPHON

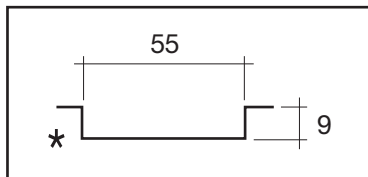

**BONDE
ET SIPHON
INCLUS**



**SANS
TROP
PLEIN**

**PAS DE TUBE
ANNELÉ**

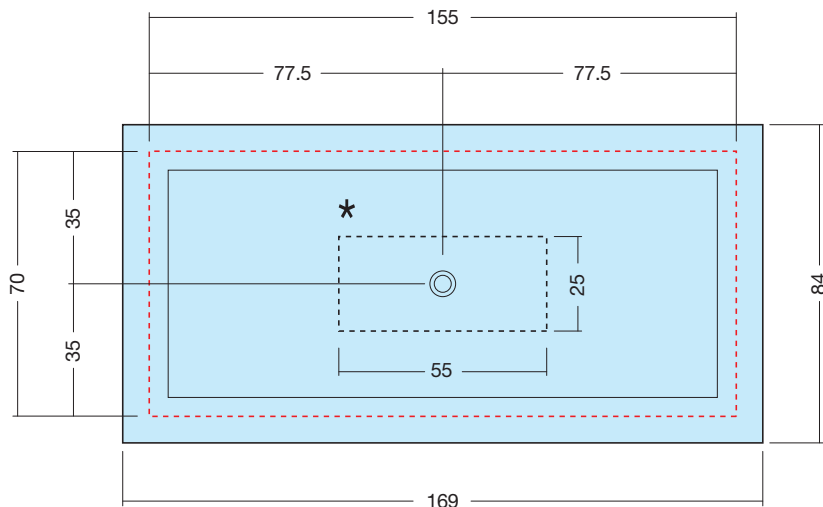

ARTICOLI

LABS1L

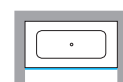

LABS2L



LABS3L



LABS4L

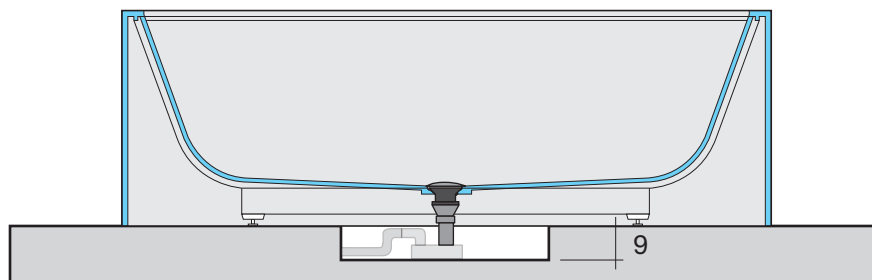
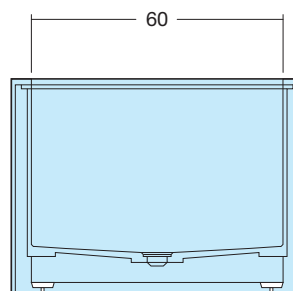
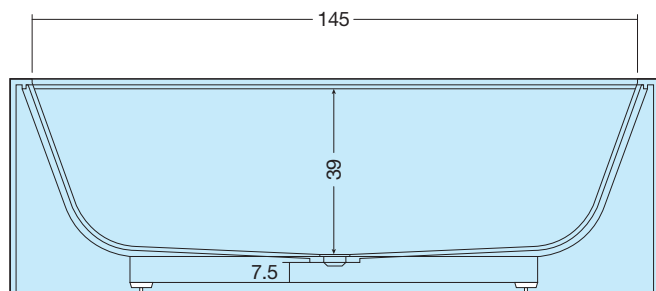

DISENIA

Disenia srl
via A. Carpenè, 21
33070
Brugnera (PN)
Italy

INFO
Tel. +39 0434 1822603
Fax +39 0434 020013
www.disenia.it
e-mail: info@disenia.it

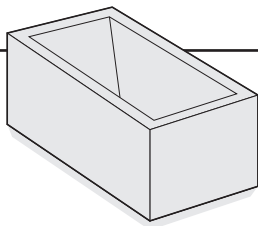

LAB MEDIUM

MATÉRIAU: CORIAN
BONDE: UP & DOWN - EN TEINTE

POIDS NET: 90 Kg
POIDS BRUT: 120 Kg
DIMENSIONS DE L'EMBALLAGE: VARIABLE
CAPACITÉ: 250 LITRES
RÉGLAGE DES PIEDS: 10 mm
DIAMÈTRE D'ÉCOULEMENT: 4 cm
TOLÉRANCE: ± 5 mm

**BONDE
ET SIPHON
INCLUS**



**PAS DE TUBE
ANNELE**

**PRÉVOIR ESPACE NÉCESSAIRE DANS LE SOL
POUR LE LOGEMENT DE LA BONDE ET SIPHON**

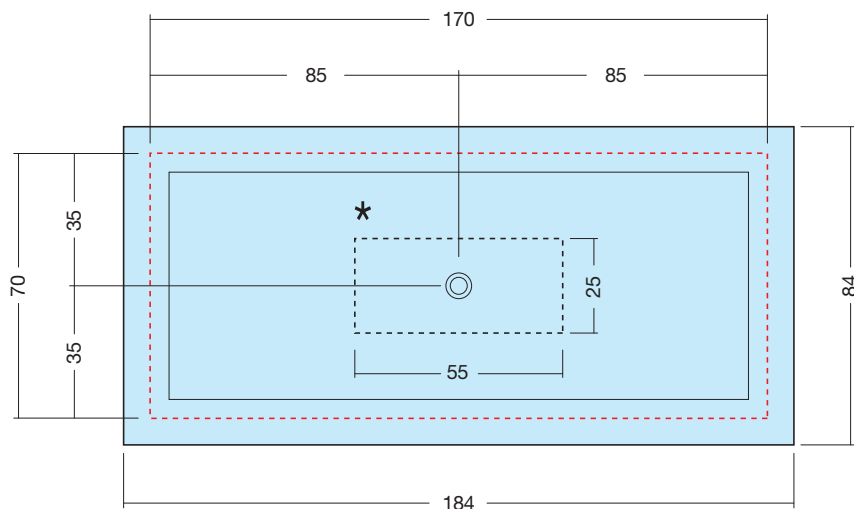
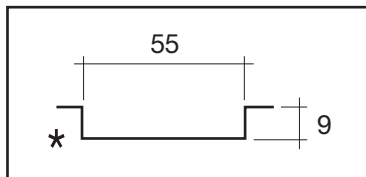

ARTICOLI	
LABS1L 	LABS2L
LABS3L 	LABS4L

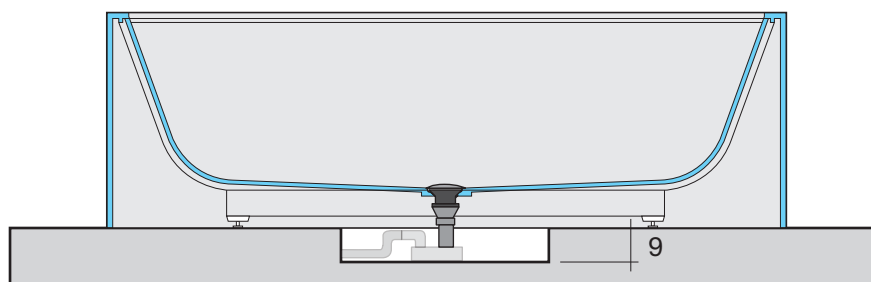
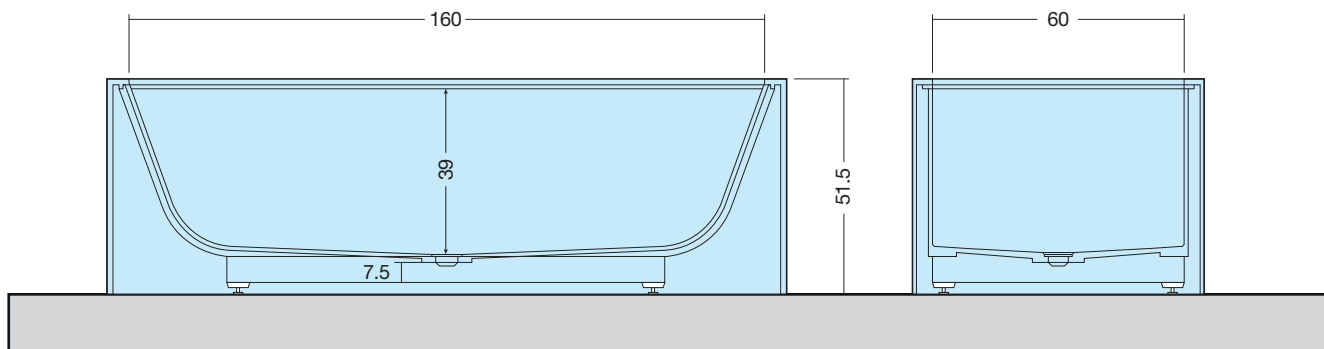

DISENIA

Disenia srl
via A. Carpenè, 21
33070
Brugnera (PN)
Italy

INFO
Tel. +39 0434 1822603
Fax +39 0434 020013
www.disenia.it
e-mail: info@disenia.it

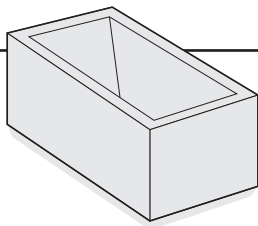

LAB LARGE

MATÉRIAU: CORIAN
BONDE: UP & DOWN - EN TEINTE

POIDS NET: 95 Kg
POIDS BRUT: 125 Kg
DIMENSIONS DE L'EMBALLAGE: VARIABLE
CAPACITÉ: 270 LITRES
RÉGLAGE DES PIEDS: 10 mm
DIAMÈTRE D'ÉCOULEMENT: 4 cm
TOLÉRANCE: ± 5 mm

**BONDE
ET SIPHON
INCLUS**



**PAS DE TUBE
ANNELE**

**PRÉVOIR ESPACE NÉCESSAIRE DANS LE SOL
POUR LE LOGEMENT DE LA BONDE ET SIPHON**

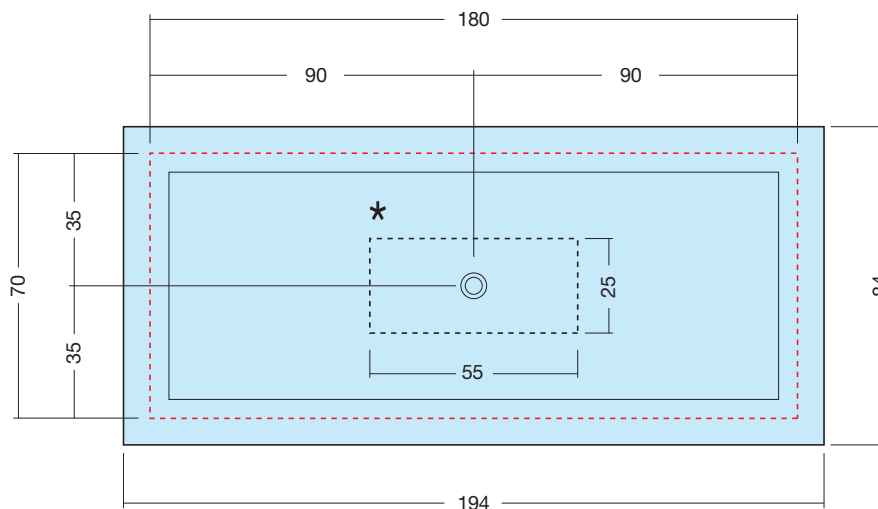
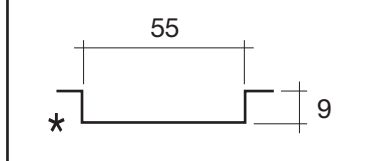

ARTICOLI

LABS1L

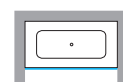

LABS2L

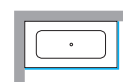

LABS3L

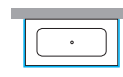

LABS4L

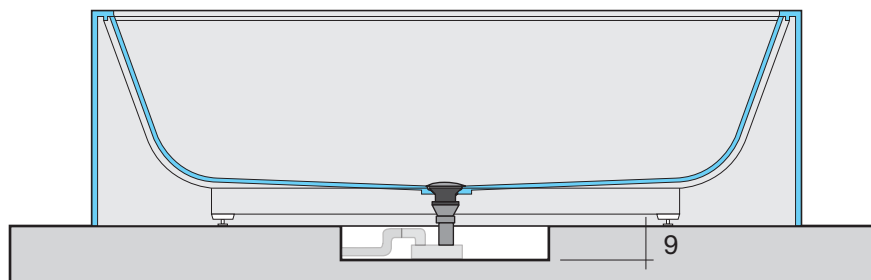
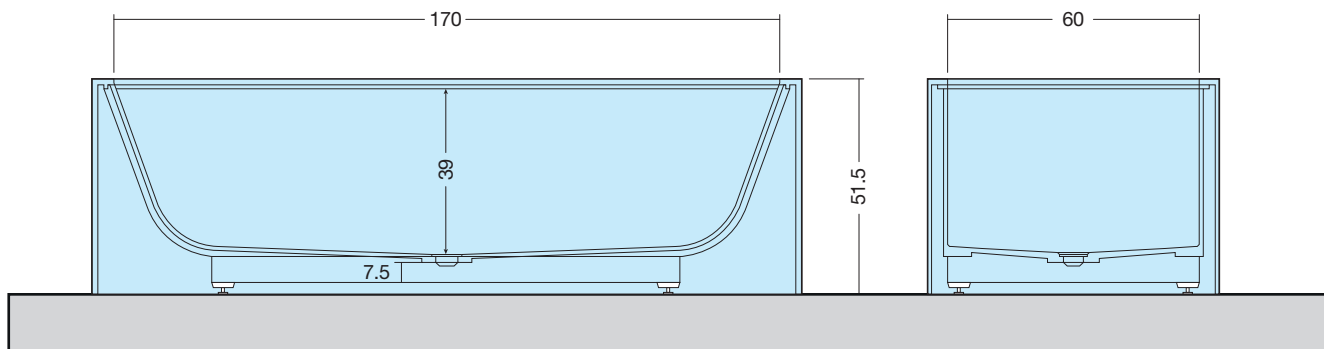
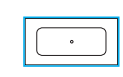

DISENIA

Disenia srl
via A. Carpenè, 21
33070
Brugnera (PN)
Italy

INFO
Tel. +39 0434 1822603
Fax +39 0434 020013
www.disenia.it
e-mail: info@disenia.it

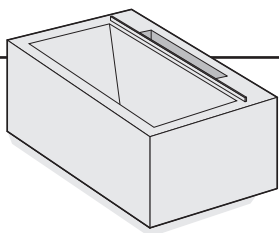

LAB SMALL

AVEC COMPARTIMENT DE RANGEMENT

MATÉRIAU: CORIAN

BONDE: UP & DOWN - EN TEINTE

POIDS NET: 85 Kg

POIDS BRUT: 115 Kg

DIMENSIONS DE L'EMBALLAGE: VARIABLE

CAPACITÉ: 230 LITRES

RÉGLAGE DES PIEDS: 10 mm

DIAMÈTRE D'ÉCOULEMENT: 4 cm

TOLÉRANCE: ± 5 mm

PRÉVOIR ESPACE NÉCESSAIRE DANS LE SOL
POUR LE LOGEMENT DE LA BONDE ET SIPHON

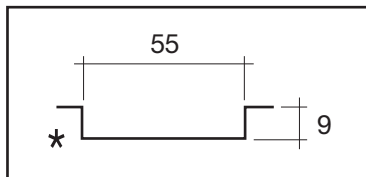

**BONDE
ET SIPHON
INCLUS**



**PAS DE TUBE
ANNELÉ**

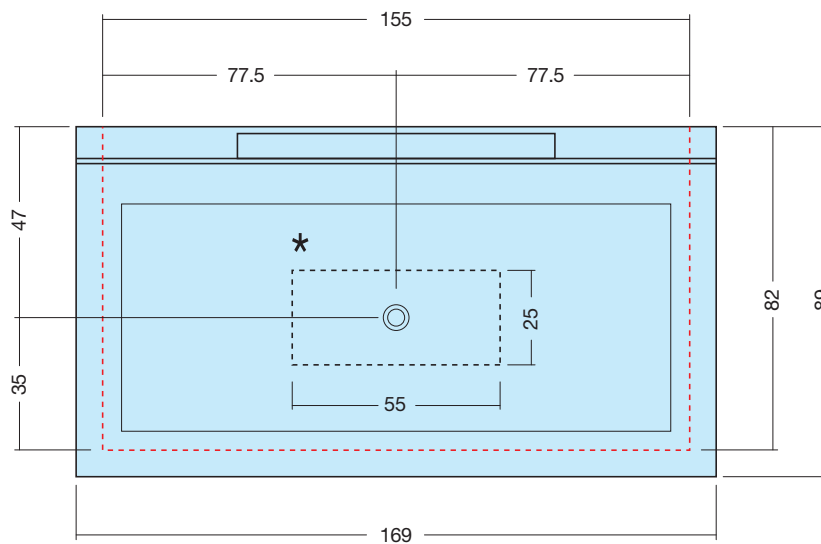

ARTICOLI	
LABS1L 	LABS2L
LABS3L 	LABS4L

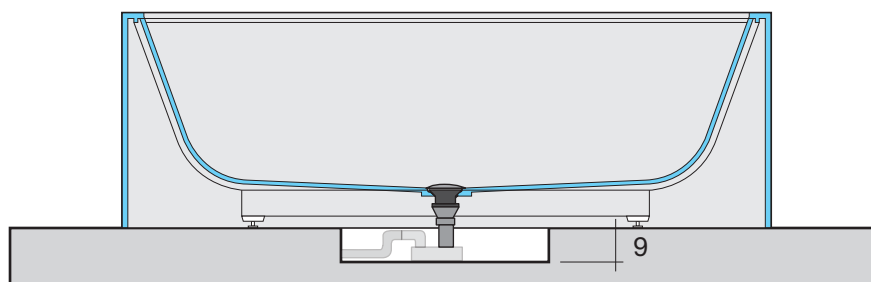
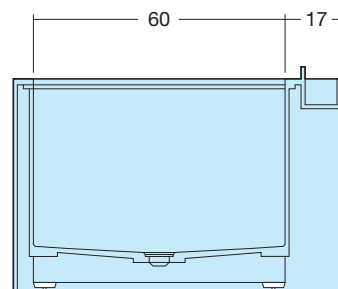
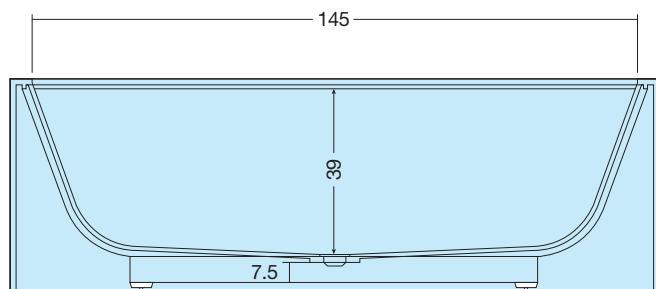

DISENIA

Disenia srl
via A. Carpenè, 21
33070
Brugnera (PN)
Italy

INFO
Tel. +39 0434 1822603
Fax +39 0434 020013
www.disenia.it
e-mail: info@disenia.it

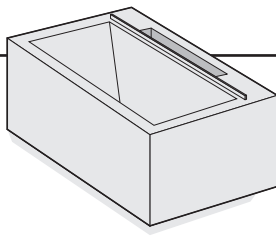

LAB MEDIUM AVEC COMPARTIMENT DE RANGEMENT

MATÉRIAU: CORIAN

BONDE: UP & DOWN - EN TEINTE

POIDS NET: 90 Kg

POIDS BRUT: 120 Kg

DIMENSIONS DE L'EMBALLAGE: VARIABLE

CAPACITÉ: 250 LITRES

RÉGLAGE DES PIEDS: 10 mm

DIAMÈTRE D'ÉCOULEMENT: 4 cm

TOLÉRANCE: ± 5 mm

**PRÉVOIR ESPACE NÉCESSAIRE DANS LE SOL
POUR LE LOGEMENT DE LA BONDE ET SIPHON**

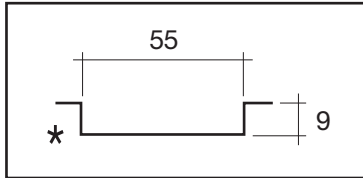

**BONDE
ET SIPHON
INCLUS**



**SANS
TROP
PLEIN**

**PAS DE TUBE
ANNELÉ**

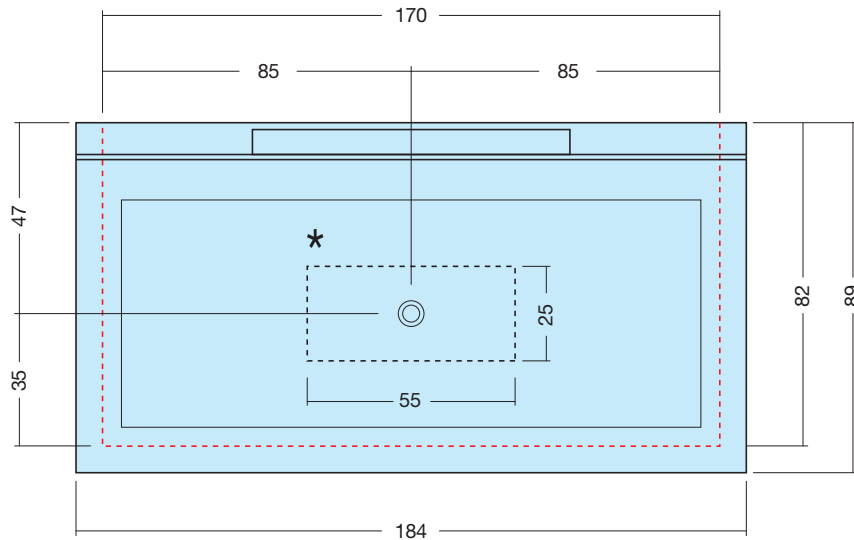

ARTICOLI	
LABS1L 	LABS2L
LABS3L 	LABS4L

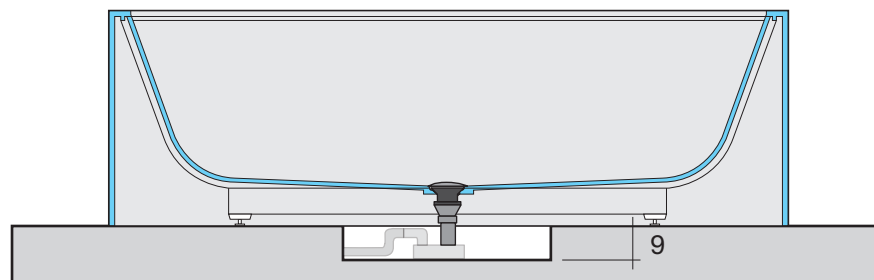
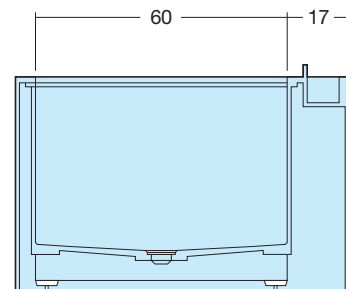
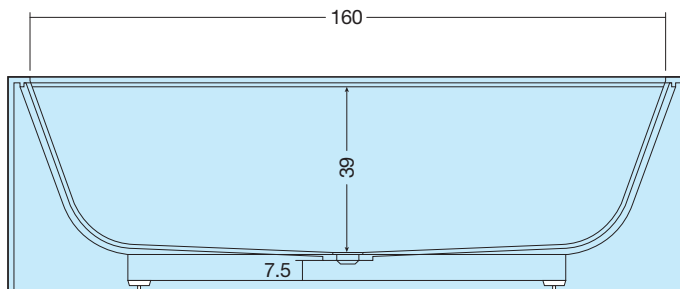

DISENIA

Disenia srl
via A. Carpenè, 21
33070
Brugnera (PN)
Italy

INFO
Tel. +39 0434 1822603
Fax +39 0434 020013
www.disenia.it
e-mail: info@disenia.it

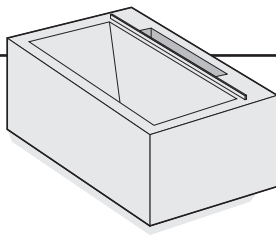

LAB LARGE

AVEC COMPARTIMENT DE RANGEMENT

MATÉRIAU: CORIAN

BONDE: UP & DOWN - EN TEINTE

POIDS NET: 95 Kg

POIDS BRUT: 125 Kg

DIMENSIONS DE L'EMBALLAGE: VARIABLE

CAPACITÉ: 270 LITRES

RÉGLAGE DES PIEDS: 10 mm

DIAMÈTRE D'ÉCOULEMENT: 4 cm

TOLÉRANCE: ± 5 mm

PRÉVOIR ESPACE NÉCESSAIRE DANS LE SOL
POUR LE LOGEMENT DE LA BONDE ET SIPHON

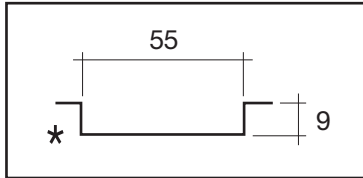

**BONDE
ET SIPHON
INCLUS**



**SANS
TROP
PLEIN**

**PAS DE TUBE
ANNELÉ**

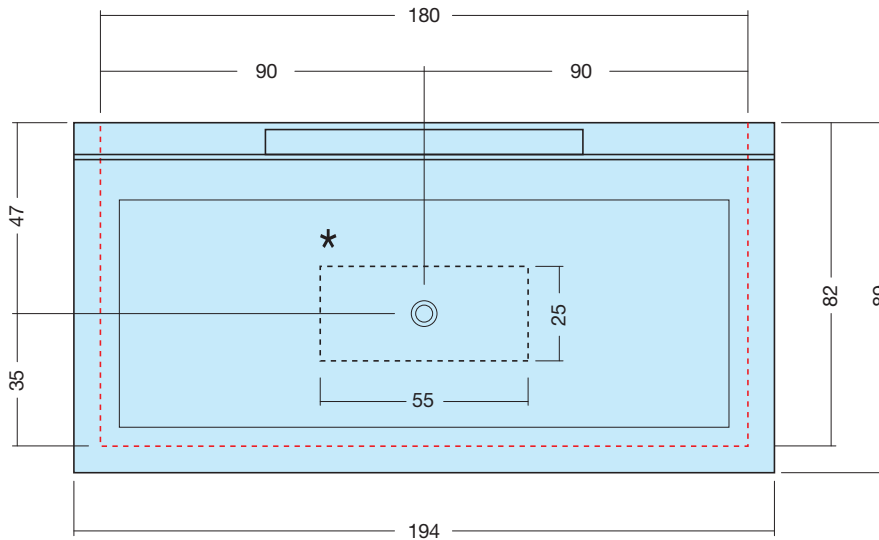

ARTICOLI

LABS1L

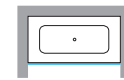

LABS2L

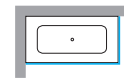

LABS3L

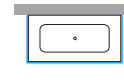

LABS4L

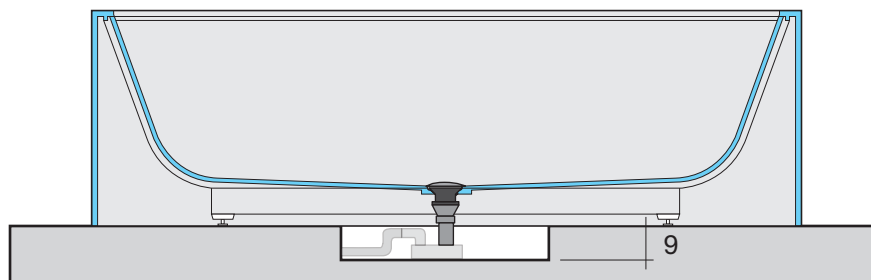
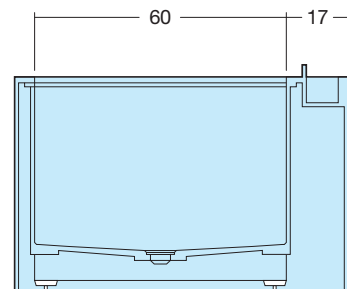
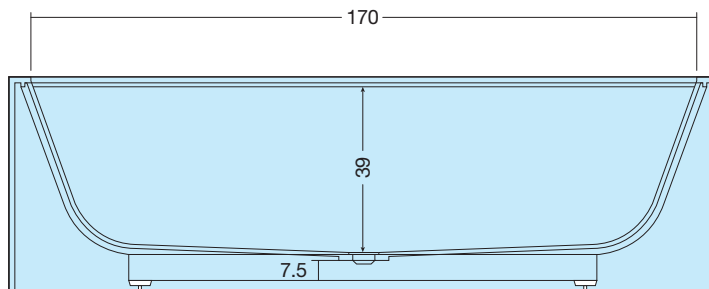
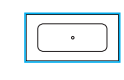

DISENIA

Disenia srl
via A. Carpenè, 21
33070
Brugnera (PN)
Italy

INFO
Tel. +39 0434 1822603
Fax +39 0434 020013
www.disenia.it
e-mail: info@disenia.it